

PROVISION **ISR**

Now you can see!



IP Series

CAMERA USER MANUAL

PROVISION-ISR

I4-390IPVF

User Manual

1080P 40m IR Vari-Focal IP Bullet Camera

For H.264 IP Camera

All rights reserved

Cautions

- Before operation, we strongly advise users to read this manual and keep it properly for using later.
- Please use the specified power supply to connect.
- Avoid from in correct operation, shock vibration, heavy pressing which can cause damage to product.
- Do not use corrosive detergent to clean main body of the camera. If necessary, please use soft dry cloth to wipe dirt; for hard contamination, use neutral detergent. Any cleanser for high grade furniture is applicable.
- Avoid aiming the camera directly towards extremely bright objects, such as, sun, as this may damage the image sensor.
- Please follow the instructions to install the camera. Do not reverse the camera, or the reversing image will be received.
- Do not operate it incase temperature, humidity and power supply are beyond the limited stipulations.
- Keep away from heat sources such as radiators, heat registers, stove., etc.
- This is product instructions not quality warranty. We may reserve the rights of amending the typographical errors, inconsistencies with the latest version, software upgrades and product improvements, interpretation and modification. These changes will be published in the latest version without special notification.
- When this product is in use, the relevant contents of Microsoft, Apple and Google will be involved in. The pictures and screenshots in this manual are only used to explain the usage of our product. The ownerships of trademarks, logos and other intellectual properties related to Microsoft, Apple and Google belong to the above-mentioned companies.
- This manual is suitable for water-proof IR network camera. This series of cameras include cost-down models and full-function models. Many functions of the cost-down models may be not covered compared with the full-function models, such as, audio out, TF card storage, PTZ configuration, alarm in/out, video search, etc. All examples and pictures used in the manual are from the full-function models.

Contents

1	Introduction	1
	1.1 Overview	1
	1.2 Package.....	1
	1.3 Connections and Focusing	1
2	Installation	4
	2.1 Connect IP-CAMERA to Network.....	4
	2.2 CMS and IP-Tool Installation.....	4
3	IE Connection.....	5
	3.1 LAN.....	5
	3.1.1 Access through IP-Tool	5
	3.1.2 Directly access through IE.....	7
	3.2 WAN.....	8
4	Remote Preview	9
	4.1 Remote Preview	9
	4.2 Playback	10
	4.3 Snap.....	11
5	Remote Configuration.....	12
	5.1 System Configuration	12
	5.1.1 Basic Information.....	12
	5.1.2 Date & Time Configuration.....	12
	5.1.3 SD Card.....	13
	5.2 Video Configuration	14
	5.2.1 Camera Configuration.....	14
	5.2.2 Video Stream.....	14
	5.2.3 Time Stamp	14
	5.2.4 Video Mask	15
	5.3 PTZ Configuration	15
	5.3.1 Protocol	15
	5.3.2 Preset Configuration	16
	5.3.3 Cruise Configuration.....	17
	5.4 Alarm Configuration.....	18
	5.4.1 Motion Detection Area	18
	5.4.2 Motion Detection Trigger	18

- 5.4.3 Motion Detection Schedule 19
- 5.4.4 Alarm Input Trigger 20
- 5.4.5 Alarm Input Schedule 20
- 5.4.6 Alarm Out 21
- 5.5 Network Configuration 21
 - 5.5.1 Port 21
 - 5.5.2 Wired 22
 - 5.5.3 NET Traversal Configuration 22
 - 5.5.4 Server Configuration 23
 - 5.5.5 IP Notify 24
 - 5.5.6 DDNS Configuration 24
 - 5.5.7 RTSP 28
 - 5.5.8 UPNP 28
 - 5.5.9 Mail Setting 29
 - 5.5.10 FTP 30
- 5.6 Advanced Configuration 30
 - 5.6.1 User Configuration 30
 - 5.6.2 Security Configuration 32
 - 5.6.3 Configure Backup & Restore 33
 - 5.6.4 Reboot Device 33
 - 5.6.5 Upgrade 33
- 6 Video Search 34
- 7 Mobile Surveillance 36
 - 7.1 Network Configuration 36
 - 7.2 By Phones with iPhone OS 37
 - 7.3 By Phones with Android 44
- 8 IP-Tool 46
- 9 Q & A 50
- 10 Specification 52

1 Introduction

1.1 Overview

This IP-CAMERA (short for IP-CAM) is designed for high performance CCTV solutions. It adopts state of the art video processing chips. It utilizes most advanced technologies, such as video encoding and decoding technology, complies with the TCP/IP protocol, SoC, etc to ensure this system more stable and reliable. This unit consists of two parts: the IP-CAM device and central management software (short for CMS). The CMS centralizes all devices together via internet or LAN and establishes a sound surveillance system to realize unified management and remote operation to all devices in one network.

This product is widely used in banks, telecommunication systems, electricity power departments, law systems, factories, storehouses, uptowns, etc. In addition, it is also an ideal choice for surveillance sites with middle or high risks..

1.2 Package

The pictures below are only for reference. Only part of our products can adjust focus. Please make the object as the standard.

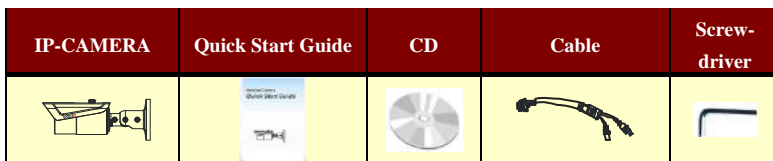

Accessories	Description
IP-CAMERA	The device without Lens
Quick Start Guide	The Brief instructions of the product
CD	CD-ROM with software and manual
Cable	Connect to monitor for video adjustment
Screwdriver	A tool for installation

1.3 Connections and Focusing

In this chapter, we will introduce the relevant connections and focusing of this device. Some cost-down modes don't support the connection of alarm in/out, RS485, TF card and some models also don't adjust focus. Please take the real object as standard.

- Connections of the external ports:

Chapter 1 Introduction

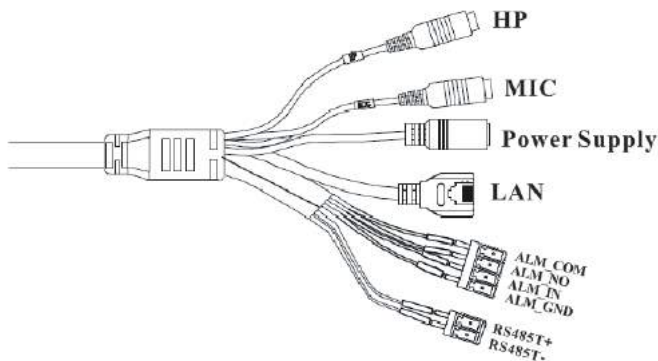

HP : Connect to headphone.

MIC : Connect to microphone.

DC12V : Power supply port.

LAN : Network port. It supports PoE power supply.

Alarm NO/COM: Alarm output. Connect to alarm output devices.

Alarm GND: Connect to external sensor together with the alarm in line.

Alarm IN: Connect to alarm input devices, like sensor, together with alarm GND line.

RS485 : Connect to keyboard or speed dome.

- Connections of the internal ports

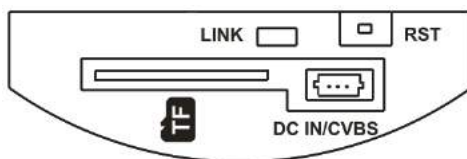

You shall remove the sun shade and lens case from the device if you want to see the above ports.

Link: Network indicator.

RST: Reset hole. Hold and press the spring blade in this hole with spicule to reset the settings to the factory default settings.

TF: Insert TF card.

DCIN/CVBS: Connect to a 3 pin joint which has a power supply port and a CVBS port in the other end. You can connect to monitor for video adjustment.

Chapter 1 Introduction

- Focus Adjustment

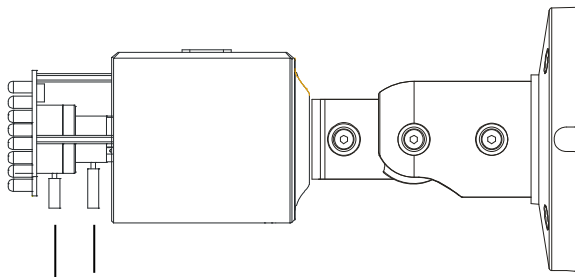

Focus Zoom

Step 1: Remove the sun shade and lens case from the device as shown above.

Step 2: Loosen the screws of the lens for focusing. Then rotate the lens left or right to adjust the focus.

Focus: Rotate left or right to adjust definition of the image.

Zoom: Rotate left or right to zoom in or out the image.

2 Installation

2.1 Connect IP-CAMERA to Network

The connection of IP-CAM is shown below:

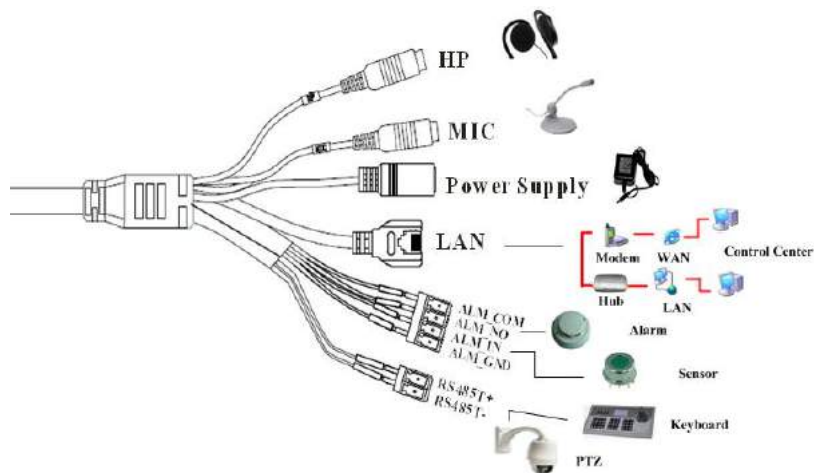

User can connect the PC and IP-CAMERA in accordance with the above picture. Before connecting, please connect external devices, and then connect the power.

2.2 CMS and IP-Tool Installation

Find CMS software from CD and then double click "Setup.exe" file to pop up installation wizard.

Install the software according to the prompts in the wizard. After you complete the installation, you will see the CMS and IP-Tool icon on the desktop. Please see the user manual of this software for more details.

If you need to install IP-Tool separately, please double click IP-Tool installation package and install it according its wizard prompts. After you finish installing, double click IP-Tool icon to start IP-Tool.

Chapter 3 IE Connection

3 IE Connection

User can connect IP-CAM through LAN or WAN. Here only take IE browser (6.0) for example. The details are as follows.

3.1 LAN

In LAN, there are two ways to access IP-CAM :①Access through IP-Tool ;②Directly Access through IE Browser.

3.1.1 Access through IP-Tool

Step 1: Make sure the PC and IP-Cam are connected to the LAN and the IP-Tool is installed in the PC from the CD.

Step 2: Use IP-Tool to modify the network of IP-Cam. Then, double click the  icon on the desktop to run this software as shown below:



After starting IP-Tool and clicking the IP-Cam in the list, user can check the information of IP-Cam. If user cannot confirm which one is himself, please shut off the electricity of the IP-Cam and then power on it. When shutting off the power, the device information will disappear. When powering on, the device information will emerge. Well, this device is the used device. Right click the device information and select “network setup”.

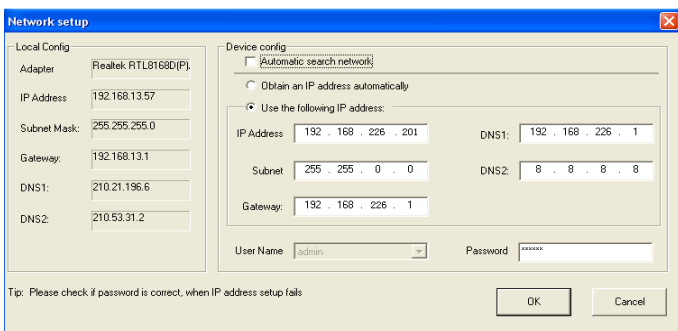

Chapter 3 IE Connection

For example, the network segment of this computer is 192.168.13.57. So, please modify the IP address, Subnet Mask, Gateway of IP-Cam which must be in the same network segment with the computer. After modifying, please input the user name and password and then click “OK” button to save the setting.

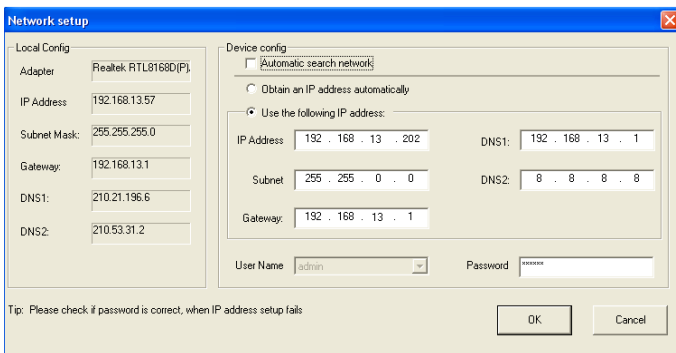

Note: The default user name is: admin. The default password is: 123456.
The new IP address of this device will display as follows after modification.



Step 3: Use the IP-Tool to login the IP-Cam.

Right-click the IP address and select “browse with IE” or double click the IP address. Then the system will pop up the IE browser to connect IP-Cam as shown below. IE browser will auto download the Active X control. After finishing the installation of the Active X control, a login window will pop up.



Chapter 3 IE Connection

Input User name and password and then click “OK” button to login.

Note: User also can use the modified IP address of the IP-Cam. Input the IP address in the IE browser bar and then click “Enter” to access IP-Cam. The default user name is admin. The default password is 123456.

3.1.2 Directly access through IE

The network service is default as shown below:

IP address: **192.168.226.201**

Subnet Mask: **255.255.255.0**

Gateway: **192.168.226.1**

HTTP: **80**

Data port: **9008**

The first you used the device, you should connect the device with the above default settings.

Step 1: Manual setup the IP address of the PC, the network segment should be as same as the default settings of IP-CAM. Right click “My Network Places” icon on the desktop→select “Properties” as shown in the following left figure. Right click “Local Area Connection” at the popup window, and then select “Property” as shown in the following right figure.



Select “Internet Protocol (TCP/IP)” in the “General” tabs→click “Properties”→Manual input network address information of the PC in the pop up window. Refer to the following figure:

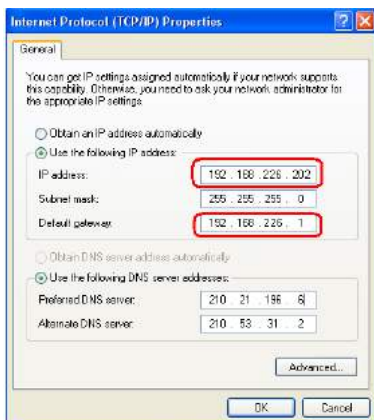

Chapter 3 IE Connection

Step 2: Open the IE Browser and input the default address of IP-CAM and confirm. Then the IE browser will download Active X control automatically.

Step 3: After downloading Active X control, the login dialog box will pop up as below:

Step 4: Input user name and password in the login dialog box and click “OK” button to enter into the live interface. You can manage and setup the IP-CAM, such as change IP address etc.

3.2 WAN

Access through router or virtual server

Step1: Connecting according to above steps in LAN; Enter into System Configuration→Network configuration→Basic configuration to setup the port number as shown in the picture on the left hand.

Step 2: Enter into System Configuration→Network configuration→IP configuration to change IP address as shown in the picture on the right hand.

Network basic config

HTTP Port	80
Data Port	9008

Port Setup

Auto search network

Auto search network

IP Config

Obtain an IP address automatically

Use the following IP address

IP Address	192 . 168 . 1 . 202	Gateway	192 . 168 . 1 . 1
Subnet Mask	255 . 255 . 255 . 0	Preferred DNS server	192 . 168 . 226 . 1
		Alternate DNS server	8 . 8 . 8 . 8

PPPoE Config

PPPoE

User Name Password

IP Setup

Step 3: Enter into the router’s management interface through IE browser; remap the IP address and port of IP-CAM in the “virtual server”. The name depends on the router.

Port Range					
Application	Start	End	Protocol	IP Address	Enabl
1	9008	to 9008	Both	192.168.1.202	<input checked="" type="checkbox"/>
2	80	to 81	Both	192.168.1.202	<input checked="" type="checkbox"/>
3	10000	to 10001	Both	192.168.1.166	<input type="checkbox"/>
4	21000	to 21001	Both	192.168.1.156	<input type="checkbox"/>
5	7777	to 7778	Both	192.168.1.206	<input type="checkbox"/>
6	1029	to 1030	Both	192.168.1.207	<input type="checkbox"/>

IP Remap

Step 4: Open the IE browser and input its WAN IP and http port to access.

4 Remote Preview

4.1 Remote Preview

After you log in, you will see the following window.



Note: The PTZ control panel, sensor alarm indicator icon and talk button cannot be seen in the cost-down models.

The descriptions of the icon on the remote preview interface:

Icon	Description	Icon	Description
	Sensor alarm indicator icon		Full screen
	Motion alarm indicator icon		Start/Stop record
	Fix size		Playback
	Actual size		Snap
	Zoom in		Talk
	Zoom out		Open/close audio

Right click mouse to appear a pull-down list as shown above:

Stream: Two streams can be selected.

Turn off the live: Click this item will close present live preview.

Enable audio: Enable remote audio transmission.

Full screen: The live preview picture will full-screen display. Double click or click right mouse to return to the previous interface.





Online user: Display user's list connect to the device.

Chapter 4 Remote Preview

System information: Display the device information: device name, firmware version, software build date, kernel version and hardware version.

Click PTZ extended button to unfold PTZ control panel.

The descriptions of the control panel are as follows:

Button	Description
	▲ to rotate the dome upwards ; ▼ to rotate the dome downwards; ◀ to rotate the dome towards left; ▶ to rotate the dome towards right ; ■ to stop rotating the dome.
	Drag the scroll bar to adjust rotating speed of the dome.
	Focus button. Click + button to have long focus and click - to have short focus so that you can adjust the image clearly.
	Zoom button. Click + to zoom in the image; click - to zoom out the image.
	Iris button. Click + to increase light of the dome; click - to decrease light of the dome.

4.2 Playback

Click  icon to see the following window:



After selecting the record date, the record files will be displayed in the record file list box. User can double click a certain record file to playback or check a certain file. Then click Play button to do playback. User can do relating operation according to some buttons in the playback interface.

Chapter 4 Remote Preview

4.3 Snap

Select the picture number, and then click “Snap”  icon as shown below:

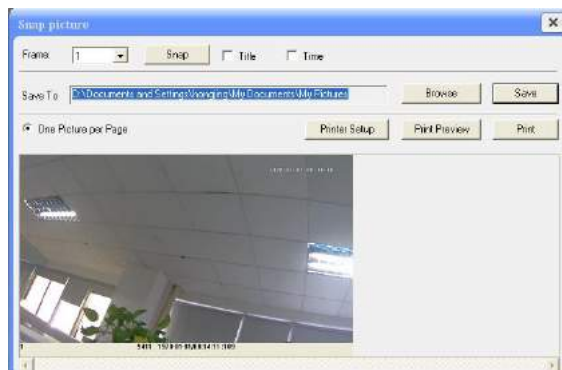

User can snap multiple pictures. Select the picture number from Frame pull down list box, such as 2, and check “Title” and “Time” to show capture title and time on the snap pictures simultaneously.

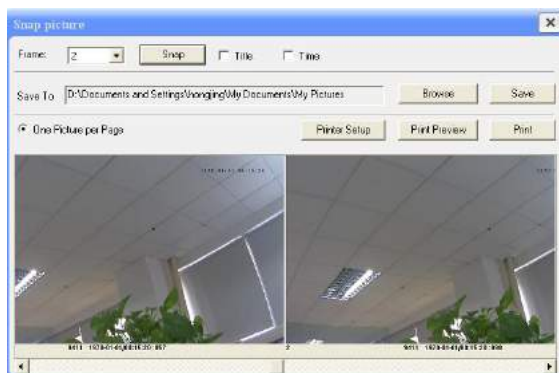

Click “Browse” to set saving path; Click “Save” to save pictures to HDD on the computer; Click “Printer setup” to set the printer and print the snap pictures; drag the scroll bar to view all snapped pictures.

5 Remote Configuration

Functions of remote configurations include: System Configuration, Video Configuration, PTZ Configuration, Alarm Configuration, Network Configuration and Advanced Configuration. You should firstly select the menu on the left, and then setup the relative parameters. When one user configures parameters of a certain device, other users can not setup this device.

5.1 System Configuration

The “System configuration” includes three submenus: Basic Information, Date & Time and SD card.

5.1.1 Basic Information

In the “Basic Information interface, user can setup the device name and also can check the relative information of the server

Setting steps:

1. Clicking the "Config" icon will appear the menu list.
2. Clicking the “Basic Information "will pop up a window as shown below:

System Infomation	
Software Version	3.3.3
Software Build Date	2013-9-4 (YYYY-MM-DD)
Kernel Version	20130606
Hardware Version	1.2
MAC	00:14:24:34:44:69
Maximum number of	4
Device name	name

<i>Parameter</i>	<i>Meaning</i>
Software version	The software of the device
Software build date	The software build date of the device
Kernel version	The kernel version of the device
Hardware version	The hardware version of the device
Mac Address	MAC address of device
Maximum number of user	Support max 4 users to access
Device name	Name of the device.

3. Input the name of the device in the "Device name" text box.
4. Press the "Save" button to save the settings.

5.1.2 Date & Time Configuration

Setting steps:

1. Enter into "System Configuration" → “Date & Time”.

Chapter 5 Remote Configuration

Date and Time setting

Set manually 6/ 5/2013 5:01:37 PM Modify time

Time Zone (GMT) Greenwich Mean Time : Dublin, Edinburgh, Lisbon, London

Daylight setting

DST Enable

DST Mode Week Mode Time offset 1

Start month	Jan	End month	Jan
First	Sun	First	Sun
Start Time	12:00:00 AM	End Time	12:00:00 AM

NTP server setting

Synchronize with NTP Server

NTP Server time.windows.com

2. Select "Modify Time ", user can self-define time. Choose the right "Time Zone" according to user's location.
3. User can also enable DST and set DST mode and time.
4. User can setup time by select the "Synchronize with NTP Server".
5. Press the "Save" button to save the settings.

5.1.3 SD Card

Setting steps:

1. Enter into "System Configuration" → "SD Card" as shown below:

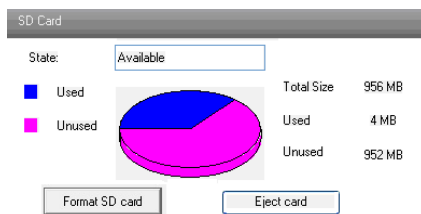

Click "Format SD card" to format SD card.

Click "Eject card" to stop writing data to SD card. Then the SD card can be ejected safely.



Note: Using of SD card function should be coordinated with motion alarm. When alarm is triggered, the system will automatically snap picture and save the picture into SD card.

Chapter 5 Remote Configuration

5.2 Video Configuration

Camera Configuration includes four submenus: Camera Configuration, Video Stream, Time Stamp and Video Mask.

5.2.1 Camera Configuration

Setting steps:

1. Enter into "Video Configuration" → "Camera" interface as shown below:



2. Adjust Brightness, Contrast, Hue and saturation of the picture.
3. Select white balance mode.
4. Sharpen, denoise, frequency, CVBS format and day-night are adjustable.
5. Enable auto iris, the image mirror and image overturn function.
6. Press the "Save" button to save the settings.

5.2.2 Video Stream

1. Enter into "Video configuration" → "Video Stream" to see a interface as shown below:

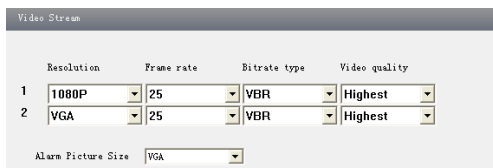

2. Select the resolution of the single frame image at the "Resolution" pull down list.
3. Select the quantity of video per second at the "Frame rate" pull down list.
4. Select the data stream type at the "Bit rate type" pull down list.
5. Set the video quality at the "Video quality" pull down list.
6. Choose the alarm picture size.
7. Press the "Save" button to save the settings.

5.2.3 Time Stamp

Enter into "Video configuration" → "Time Stamp" to display the interface as shown below:

Chapter 5 Remote Configuration

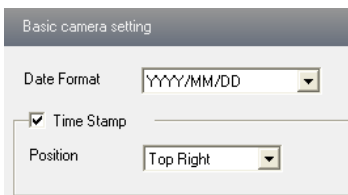

Here you can set date format and the position of the time stamp shown in the live image.

5.2.4 Video Mask

You can set 4 mask area at most.

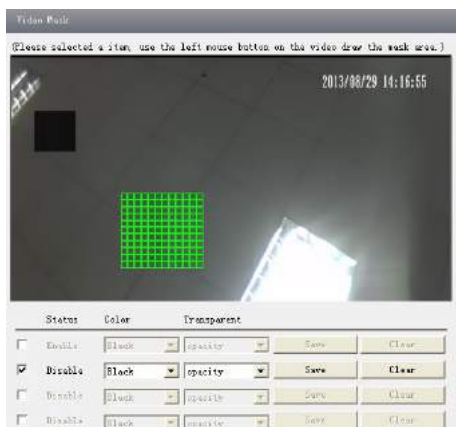

Enable the mask, select color and transparent of the mask area and then drag the mouse to set the mask area. This will take you see a gridding area. After that, click “Save” button to save the settings. Then you will see a mask area on the live image.

5.3 PTZ Configuration

PTZ Configuration includes three submenus: Protocol, Preset and Cruise.

5.3.1 Protocol

1. Enter into "PTZ Configuration" → "Protocol" interface as shown below:

Chapter 5 Remote Configuration



2. Tick off "Enable/Disable PTZ Config", and then reboot IE client side, the PTZ control panel will be displayed on the live interface.
3. Select the protocol of the PTZ device at the "Protocol" pull down list.
4. Input address of the PTZ in the "Address" textbox.
5. Select baud rate of the PTZ in the "Baud rate" pull down list.

For the settings of protocol, address and baud rate please refer to the user manual of the PTZ setting.

5.3.2 Preset Configuration

1. Enter into "PTZ Configuration" → "Preset" to see a interface as shown below:



Button	Meanings
	▲ to rotate the dome upwards; ▼ to rotate the dome downwards; ◀ to rotate the dome towards left; ▶ to rotate the dome towards right; ■ to stop rotating the dome.
	Focus button. Click + button to have long focus; click - button to have short focus.
	Zoom button. Click + button to zoom in the locale picture ; click - button to zoom out the locale picture.
	Iris button. Click + button to increase light of the dome; click - button to decrease the light of the dome.
	Drag the scroll bar to adjust rotating speed of the dome.

Chapter 5 Remote Configuration

2. Input the preset number and set its position by controlling PTZ control panel and then click Add button to add preset point into the Available position list.
3. Select the preset in the pull down list of the Available position and click Go to button to move the dome to this preset point; click Delete button to delete checked preset point.
4. After finishing setting, click Save button to save the settings

5.3.3 Cruise Configuration

Enter into "PTZ Configuration" → "Cruise" to display an interface as shown below:

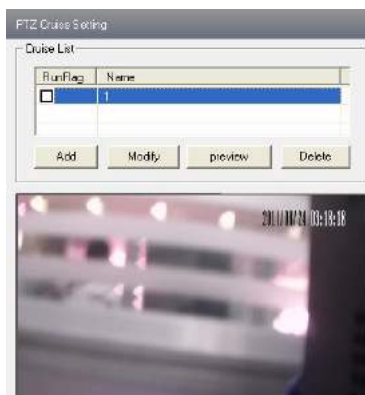

Click "Add" button to add cruise.

Choose a cruise and click "Modify" button to pop up a window as below:

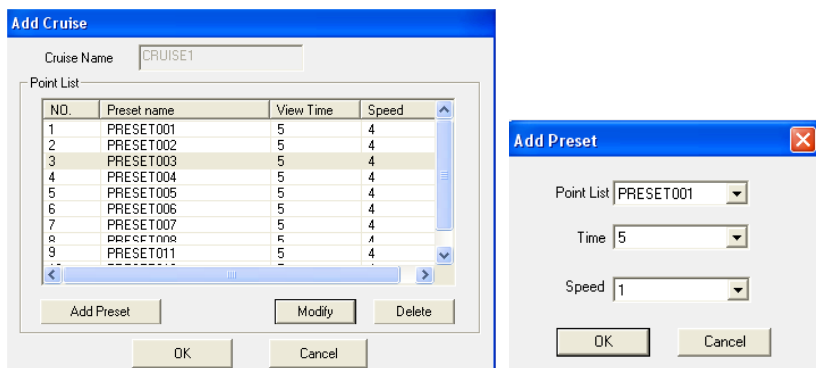

Click "Add Preset" button to pop up a window. You can add the preset there.

Click "Preview" button to check the related information of this cruise and click "Delete" button to delete this cruise.

4. Press the "Save" button to save the settings.

Chapter 5 Remote Configuration

5.4 Alarm Configuration

Alarm configuration includes six submenus: Motion Detection Area, Motion Detection Trigger, Motion Detection Schedule, Alarm Input Trigger, Alarm Input Schedule and Alarm Out.

5.4.1 Motion Detection Area

1. Enter into "Alarm configuration"→"Motion Detection Area" to see a interface as shown below:

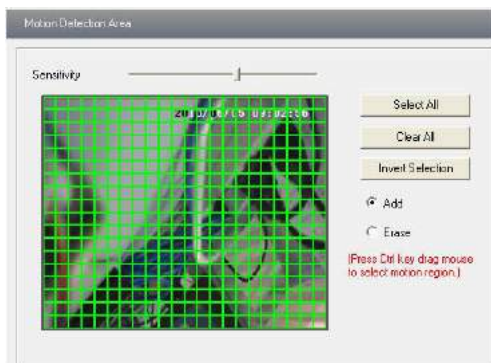

2. Move the "Sensitivity" scroll bar to setup the motion trace sensitivity.
3. Check the "Add", press the "Ctrl" button and move mouse to select the motion detection area; Select "Erase" and move the mouse to clear all motion detection area.
4. Press the "Save" button to save the settings.

5.4.2 Motion Detection Trigger

1. Enter into "Alarm Configuration"→ "Motion Detection Trigger" to display a interface as below:

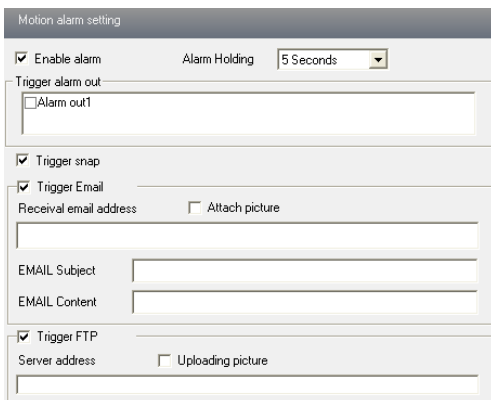

Chapter 5 Remote Configuration

2. Check "Enable alarm" check box. Then motion based alarm is activated.
3. Set alarm holding time.
4. Set alarm trigger options.

Alarm Out: If selected, this would trigger the external relay output on detecting a motion based alarm.

Trigger Snap: If selected, the system will snap images on an alarm and save them in SD card.

Trigger Email: If the email and attach picture checkbox is checked (Email address shall be set first in the Mail config interface), the triggered snap pictures and event will be sent into those address.

Trigger FTP: If "Uploading picture" is checked, the triggered snap pictures will be sent into FTP server address. Please refer to FTP configuration chapter for more details.

5. Press the "Save" button to save the settings.

5.4.3 Motion Detection Schedule

A window will show as below by entering into "Alarm configuration" → "Motion Detection schedule" menu.

Motion schedule setting

Erase Add

Week Schedule

Day	0	1	2	3	4	5	6	7	8	9	10	11	12	13	14	15	16	17	18	19	20	21	22	23	24
Sunday																									
Monday																									
Tuesday																									
Wednesday																									
Thursday																									
Friday																									
Saturday																									

Holiday Schedule

Date: 12/17/2009

Day	0	1	2	3	4	5	6	7	8	9	10	11	12	13	14	15	16	17	18	19	20	21	22	23	24
Holiday																									

Week schedule

User could set the alarm time from Monday to Sunday for alarm everyday in one week.

Note: The lengthwise means one day of a week; the rank means 24 hours of a day. Mouse clicks on the pane to set the alarm hours. Green means selected area. Blank means unselected area.

2. "Add": add the schedule for a special day.
3. "Erase": delete holiday schedule

Day schedule

User could set alarm time for alarm in some time of special day, such as holiday.

Chapter 5 Remote Configuration

1. Select a date at the "Date" pull down list, press "Add" button to add that date to the list box on the right side and then move the scroll bar to set the schedule of that day.
2. Select a date in the list box on the right side, and press "Erase" to remove the schedule on that day.

Press the "Save" button to save the settings.

Holiday schedule is prior to Week schedule.

5.4.4 Alarm Input Trigger

1. Enter "Alarm Configuration" → "Alarm Input Trigger" to see a screen as shown below:

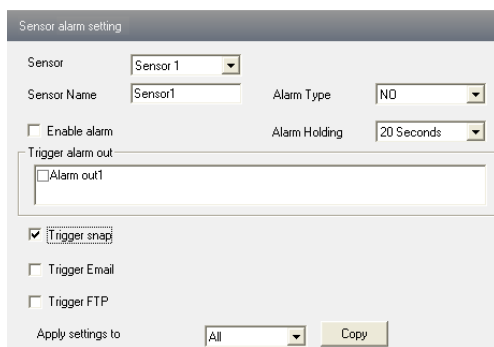

2. Select the sensor at the "Sensor" pull down list and set the sensor name and alarm type: NO and NC.
3. Enable alarm and select alarm holding time.
4. Set alarm trigger options. The setting steps are the same with that of motion detection trigger. Please refer to motion detection trigger chapter for details.
5. Apply settings to all by clicking "Copy" button, which can quickly set the same settings for all sensors.

5.4.5 Alarm Input Schedule

Enter into "Alarm Configuration" → "Alarm Input Schedule" as shown below:

1. Select the sensor which needs to setup the alarm parameter at the "Sensor" pull down list
2. The following setup steps are similar to Motion Detection Schedule's. Please refer to Motion Detection Schedule chapter for more details

Chapter 5 Remote Configuration

Sensor schedule setting

Sensor: Sensor1 Erase Add

Week Schedule

Sun

Mon

Tue

Wed

Thu

Fri

Sat

Holiday Schedule

Date: 7/1/2013 Add Delete

Holiday

Copy settings

Apply settings to: All Copy

5.4.6 Alarm Out

1. Enter into "Alarm configuration" → "Alarm output" as shown below:

Alarm out setting

Alarm Out: Alarm out1

Alarm Holding Time: 10 Seconds

2. Select alarm holding time and alarm name at the "Alarm out" and "Alarm holding time" pull down list box respectively.
3. Press the "Save" button to save the settings

5.5 Network Configuration

Network configuration includes ten submenus: Port, Wired, NET Traversal Configuration, Server Configuration, IP Notify, DDNS Config, RTSP, UPNP, Mail Setting and FTP.

5.5.1 Port

1. Enter into "Network config" → "Port" to see the interface as shown below:

Chapter 5 Remote Configuration

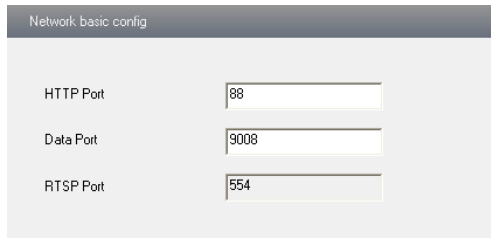

Network basic config

HTTP Port	88
Data Port	9008
RTSP Port	554

2. Input port number for IE access in the "HTTP Port" textbox.
3. Input the port number for audio & video transmission in the "Data Port" textbox.

5.5.2 Wired

1. Enter into "Network Configuration" → "Wired" to see a tab shown below:

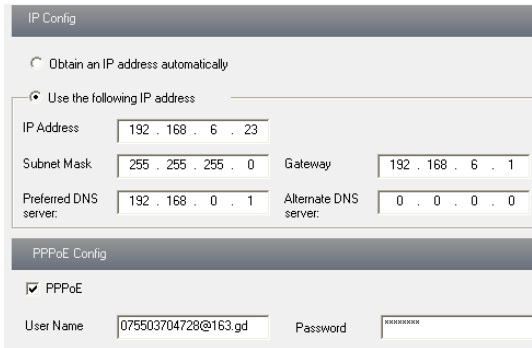

IP Config

Obtain an IP address automatically

Use the following IP address

IP Address	192 . 168 . 6 . 23		
Subnet Mask	255 . 255 . 255 . 0	Gateway	192 . 168 . 6 . 1
Preferred DNS server:	192 . 168 . 0 . 1	Alternate DNS server:	0 . 0 . 0 . 0

PPPoE Config

PPPoE

User Name	075503704728@163.gd	Password	*****
-----------	---------------------	----------	-------

2. There are two Options for setup IP: obtain an IP address auto by DHCP protocol and use the following IP address, user can choose one of options for requirements.
3. Use the following IP address: display the IP address, subnet mask, gateway and DNS of the device.
4. PPPOE: User needs to manual input the user name and password for dial-up internet. Firstly, user needs to login IE clients, then enter into user name and password of PPPoE, save the setting and exit. Secondly, setup IP address change notice. Thirdly, connect with Modem, then the device will dial-up internet automatically.
6. Press the "Save" button to save the settings.

5.5.3 NET Traversal Configuration

In this interface, user can access to network without dynamic domain name and port forwarding by enabling NET transit.

1. Enter into "Network Configuration" → "NET traversal Config".

Chapter 5 Remote Configuration

Transit

Transit enable

Serial: 03450940

Online status: on-line

user-defined name: IPCAM availability when on line

2. Check “transit enable”. Then save the setting.
3. Input www.upnpcp.com in IE address; download and install Active X. Then a window shows up as below:

Client version: 2.1.4.4

User Name: admin

Password: [Empty]

Bitrate type: 1.720P-25fps

Language: English

save the password

OK Cancel

4. Input the only device ID of the IP-CAM or user-defined name. And then input user name and password.

5.5.4 Server Configuration

Enter into “Network Configuration”→ “Server Config”.

Server Config

Do you want IPCamera to connect Server

Server Address: [Empty]

Server Port: 0

Device ID: 1

1. Check “Do you want IP Camera to connect Server”.
2. Check the IP address and port of the transfer media server in the ECMS/NVMS. Then enable the auto report in the ECMS/NVMS when adding a new device. Then input the remaining information of the device in the ECMS/NVMS. After that, the system will auto allot a device ID. Please check it in the ECMS/NVMS.
3. Input the above-mentioned server IP, server port and device ID in the responding boxes.

Chapter 5 Remote Configuration

Click “save” button to save the settings.

5.5.5 IP Notify

1. Enter into “Network Configuration”→”IP Notify” to see a tab as below.

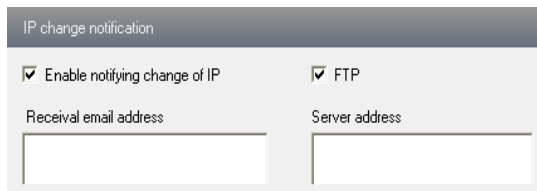

The screenshot shows a configuration window titled "IP change notification". It contains two checked checkboxes: "Enable notifying change of IP" and "FTP". Below these are two input fields: "Receival email address" and "Server address".

2. If the “Enable notifying change of IP” is selected, when the IP address of the device is changed, a new IP address will be sent to the appointed mailbox automatically; If “FTP” is selected, when the IP address of the device was changed, a new IP address will be sent to FTP server.

5.5.6 DDNS Configuration

1. Domain name Registration (<http://provision-isr-dns.com>)

Note: DDNS is used to register for a hostname with DDNS username and password.

Provision ISR now allows you to use our mint DDNS server in order to create a virtual address for your DVR/NVR/IP-Camera on the internet. Each account is limited to 35 different addresses using your preferred domain name address instead of using IP addresses. Follow the steps below to register your DVR's name and to configure your DVR to use Provision ISR's Mint DDNS server.

(a) **To register a domain with Provision-ISR DDNS server follow these steps:**

1) Visit our website:

<http://provision-isr-dns.com>

and register for a domain name by clicking

"Registration"



Chapter 5 Remote Configuration

- 2) Fill in the registration form, then click

"Submit"



- 3) Fill in the host name you want to apply for and press **"Request Domain"** (for example **"home"**)



- 4) If there is no problem with the domain registration you will see the following message: **"Your domain was successfully created."**

If you do not see this message, the domain name you requested is already in use and you will be requested to provide an alternate domain name (please note: *domain name* is sometimes called *host name*).

You can create up to 35 domain records under a single account



- 5) The domain name is added at the beginning of your DVR's address, for example the domain **"home"** will appear as **home.provision-isr-dns.com**.

Chapter 5 Remote Configuration

1. Enter into "Network Configuration" → "DDNS Configuration" tab as below:

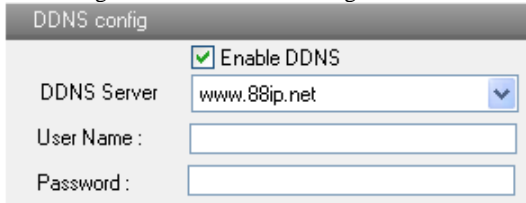

Note: The steps to band a domain name for video surveillance server are as follows. Firstly, register a user name and a password to log on the website of service supplier, and then apply for a domain name online for the server. After that, users can visit the server through inputting the domain name at IE terminal.

2. Press the "Save" button to save the settings.

Please refer to the following table for parameters and instructions of DDNS configuration.

<i>Parameter</i>	<i>Meaning</i>
<i>DDNS server</i>	Address of the website which provided by domain name supplier. The optional: www.dns2p.net , www.88ip.net , www.meibu.com , www.dyndns.com , www.no-ip.com , www.3322.org and mintdns type .
<i>User name</i>	Log in the website of domain name supplier
<i>Password</i>	Log in the website of domain name supplier

1. Apply the Domain Name (Take dns2p for example)

(1) Register in the Web

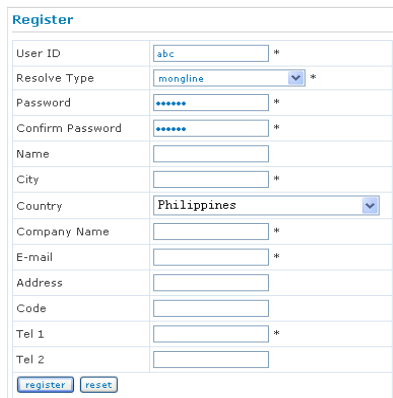

Register dialog box

Step 1: Fill in the blank of IE address with 'www.dns2p.com'.

Step 2: Click  to enter the website.

Chapter 5 Remote Configuration

Step 3: Click "New User" in the right of homepage to register. For example: User ID is 'abc', and password is '123456'. The register dialog display as above.

(2) Login

Step 1: Return to homepage after registering successfully.

Step 2: Click "Account Manager" on the right of homepage to login.

Step 3: Input the username and password with the information that you have registered.

Step 4: Click "Enter" key after filling in the textbox.

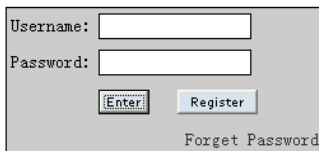

A login form with a light gray background. It contains two input fields: 'Username:' and 'Password:'. Below the 'Password:' field are two buttons: 'Enter' and 'Register'. At the bottom right of the form is a link labeled 'Forget Password'.

Log in

(3) Domain Setup

Step 1: Click "Domain Management" on the left to set the domain.



A domain setup form with a blue header. It contains a 'Domain:' label, a text input field with 'www.' inside, a dropdown menu showing '. dns2p. com', and a 'Submit' button.

Domain setup

Step 2: Input the domain in the textbox. For example, you set 'IP-CAMERA' as the domain.

Step 3: Click "Submit" button, the system will pop up a dialog box to show that the domain is added successfully.

Note: Time of probationary period is one month. If user wants to use it continually after one month, please Step 4: click "Buy Now" in the right of homepage to pay for it.

2. Setup in the IP-CAMERA

(1) DOMAIN

Domain is set in '1. Apply the Domain Name'. According to the example above, the domain is 'WWW. IP-CAMERA.dns2p.com'.

(2) USER ID

Username of registered which is set in '(1) Register in the Web'. According to the example above, user ID is 'abc'.

(3) PASSWORD

Password is set in '(1) Register in the Web'. According to the example above, password is '123456'.

Note: If the connection fails, press the "INFO" button. Now the system will display: 'DDNS NONE'. Then you need to check network and information above and try again.

Chapter 5 Remote Configuration

3. Application

Connect IP-CAMERA to the Network Client.

Step 1: After popping up the login interface, fill in "Server" textbox with '*.dns2p.com' to visit the Network Client of the IP-CAMERA. The domain set in '(3) Domain Setup'.

According to the example above, fill in "Server" textbox with 'IP-CAMERA.dns2p.com'.

Step 2: Click "save" button to save the above setting.

5.5.7 RTSP

Enter into "Network Configuration" → "RTSP" interface as shown below:

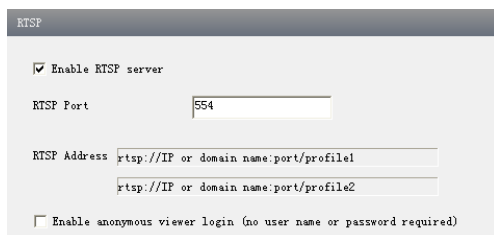

1. Select "Enable RTSP server."
2. RTSP Port: Access Port of the streaming media. The default number is 554.
3. RTSP Address: The RTSP addresses are inputted in the media player.

Application: This device supports VLC player. You can upload the VLC player in the related website and then select "File" → "Open URL" from the tool bar of the player. You will see the live image which is the same with that of playing through IE.

5.5.8 UPNP

Enter into "Network Configuration" → "UPNP" interface as shown below:

Select "Enable UPNP" and then input friendly name.



Enable UPNP

Double-click the "My Network Places" icon on the desktop in PC and select "Show icons for networked UPnP devices" in the "Network Tasks" list box. Then an information window will pop up. Click "YES" button to see a "Windows Components Wizard" dialog box pop up as shown below. Then press "Next" to continue. After finished the installation of configuring components, the UPnP icons will display. Users can double-click certain icon to connect the

Chapter 5 Remote Configuration

remote surveillance login interface through IE.



If “Show icons for networked UPnP devices” can’t display in the “Network Tasks” list box, please follow the below operation:

- Click “Tools”-- “Folder options”
- Check the “Show common tasks in folders” in the “Tasks” check box, UPnP icon will display.

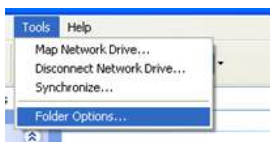

5.5.9 Mail Setting

Enter into “Network Configuration” → “Mail Setting” interface. Please refer to below picture.

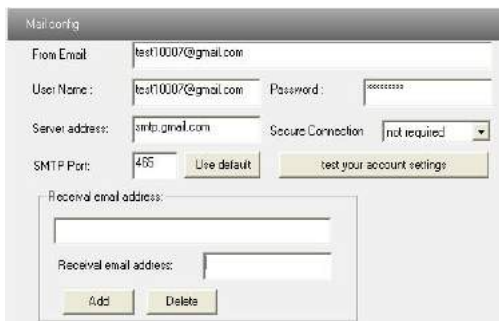

1. From Email: sender’s e-mail address
2. User name and password: sender’s user name and password
3. Server address: SMTP name of sender
4. Select the secure connection type at the Secure Connection pull down list according to user’s actual needs
5. Receive email address list: add email address into the list
6. Receive email address: receiver’s e-mail address
7. After all parameters setup, user can click “Test your account settings”. If email sent

Chapter 5 Remote Configuration

successful, a “Test Successful” window will pop up, if not, users can try other email addresses or check the setting.



Note: If you change the static IP into PPPoE and select mailbox, there will be an e-mail sent to users' mail box for notifying a new IP address.

5.5.10 FTP

Enter into Network Configuration → FTP interface; please refer to below picture.

Server name	Server address	Port...	User Name	Upload path:	

Buttons: Add, Modify, Delete, Test

1. Add: Click Add button to input FTP server's server name, address, port number, user name, password, and upload path, click OK to confirm the setting. Refer to the following picture:

Modify: You can click this button to change some information of the FTP server

Delete: Select certain FTP account; Click this button to delete this account

Test: Select certain FTP account; Click this button to test its valid or not.

Please refer to the following table for parameters and instructions of FTP configuration.

Fields: Server name, Server address, Port (21), User Name, Password, Confirm Password, Path

Buttons: OK, Cancel

<i>Parameter</i>	<i>Meaning</i>
<i>Server name</i>	The name of the FTP server
<i>Server address</i>	The address of the FTP server
<i>Port</i>	The port number of the FTP server
<i>User name</i>	The user name of the FTP server
<i>Password</i>	The password of the FTP server
<i>Path</i>	The save path for FTP files

5.6 Advanced Configuration

Advanced configuration includes five submenus: User Configuration, Onvif Configuration, Security Configuration, Configure Backup & Restore, Reboot and Upgrade.

5.6.1 User Configuration

Enter into "User Configuration" interface. Refer to the following picture:

Chapter 5 Remote Configuration

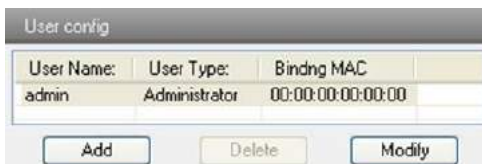

Add user:

1. Clicking "Add" button pops up "Add user" dialog box as shown below:

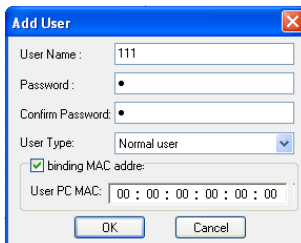

After binding physical address to the IP-CAM, you can access the device on this PC only. If the MAC address was ““00:00:00:00:00:00” which means it can be connected to any computers.

2. Input user name in "User Name" textbox (only letters).
3. Input characters in "Password" and "Confirm Password" textbox (letters or numbers).
4. Input the MAC address of the PC in "Binding MAC address" textbox.
5. Click “OK” button and then the new added user will display in the user list.

Modify user:

1. Select the user which needs to modify password and physical address in the user configuration list box.
2. Clicking “Modify” button will pop up “Modify user” dialog box as shown below.

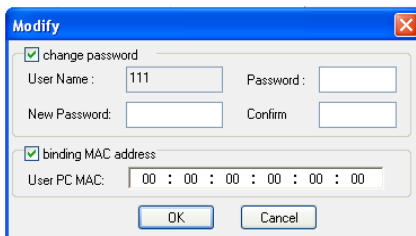

3. Input original password of this user in the “password” text box.
4. Input new password in the “New password” and “Confirmation” text box.
5. Input computer’s physical address which is used to access the server in the “User PC

Chapter 5 Remote Configuration

MAC” text box.

6. Click “OK” button to modify user’s password and binding MAC address successfully.

Delete user:

1. Select the user which needs to delete in the user configuration list box.

2. Clicking “Delete” button will pop up a confirm dialog box. Then click “OK” to delete the user.

Note: The default super administrator cannot be deleted.

<i>Parameter</i>	<i>Meaning</i>
User Name	User name to operate the logon client end
User Type	Type of users, normal user, advanced user and super administrator
Binding MAC address	The MAC addresses of user access the server which should setup according to actual MAC address of server.
Password	Password to log in the client terminal
Confirm Password	Password to log in the client terminal

5.6.2 Security Configuration

Enter into Advanced Configuration→Security Configuration to see a tab shown below:

Check “Enable IP address” check box, select “Deny the following IP address”, input IP address in the IP address list box and click “Add” button. Then this IP address will display in the list box; the operation step of “Allow the following IP address” is the same with “Deny the following IP address”

Select the IP address which needs to be deleted from the IP address list box and click “delete” button to delete that IP address.

Check “Enable MAC address” check box, select “Deny the following IP address”, input MAC address in the MAC address list box and click “Add” button. Then this MAC address will display in the list box; the operation step of “Allow the following IP address” is the same with “Deny the following IP address”.

4. Select the MAC address which needs to be deleted from the MAC address list box and click “delete” button to delete that MAC address.

5. Click "save" button to save the above setting.

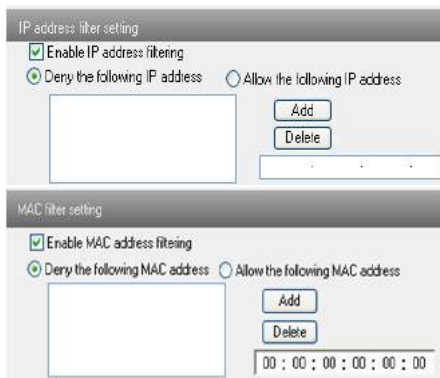

Chapter 5 Remote Configuration

5.6.3 Configure Backup & Restore

Enter into Advanced configuration→Configure Backup & Restore Interface.

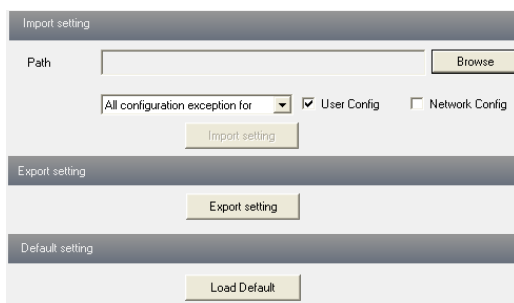

- **Import & Export Configuration:**

User can import or export the setting information from PC or to device.

1. Click “Browse” to select save path for import or export information on PC.
2. User can import or export all setting information to PC, but those two settings “user configuration” and “network configuration” are exceptional.

- **Default Configuration**

Click “Load default” button to restore all system settings to default status.

5.6.4 Reboot Device

Enter into Advanced configuration—Reboot device to see a interface as shown below:

Click “Reboot device” button to reboot the device.



5.6.5 Upgrade

Enter into Advanced Configuration—Upgrade interface.

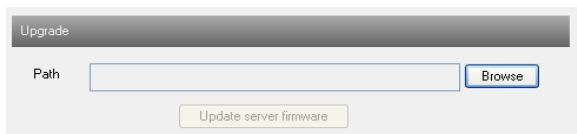

1. Click “Browse” button to select the save path of the upgrade file
2. Click “Upgrade server firmware” button to start upgrading the application program
3. The device will restart automatically
4. After you successfully update the software, click “OK” button to close IE and then re-open IE to connect IP-Cam.

Caution: You can't disconnect to PC or close the IP-CAM during upgrade.

6 Video Search

This function is not available in the cost-down series.

Click “Picture” button and search the images which saved in the TF card.

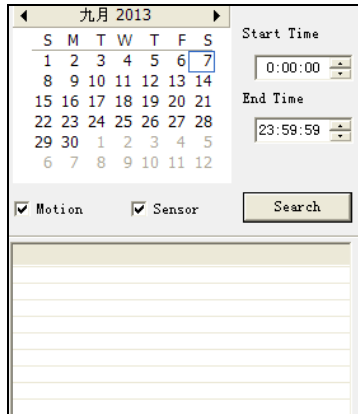











1. Select date in the “calendar”, check “motion detection” relatively and click “search” button. Then the triggered snap pictures will be displayed in the list box.
2. Double click a filename or select a filename and then click “view” button in the list box to view snap pictures.



Chapter 6 Video Search

Definitions of function buttons:

<i>Item</i>	<i>Buttons</i>	<i>Explanations</i>
1		Close: Select certain picture and click this button will close this preview picture.
2		Close all: click this button will close all preview pictures
3		Save: click this button, select the save path of the picture file on PC to save this preview picture
4		Save all: click this button, select the save path of the picture files on PC to save all preview pictures
5		Fit size: click this button, the preview pictures will fit on screen
6		Actual size: click this button to display the actual size of the preview pictures (for user's requirements)
7		Zoom in: click this button to amplify the preview picture, user can drag cursor to view request areas.
8		Zoom out: click this button to zoom out amplified preview picture
9		Slider play: click this button to play preview pictures on the mode of slider
10		Stop: click this button to stop slide show
11		Play speed: play rate of the slide show

7 Mobile Surveillance

This IP-CAM supports mobile surveillance by phones with Windows mobile, iPhone, Android and Blackberry OS. Please check the operation system version of mobile before use; and connect the IP-CAM to Internet.

7.1 Network Configuration

● Access device via LAN

Step 1: Connect device via wireless router. Then checkmark DHCP both in router and device to automatically acquire IP address or enter the IP address manually.

Step 2: Use WIFI function in your mobile phone to connect the wireless router.

Note: Make sure your phone network and device network are in the same network segment on LAN.

Step 3: Add the IP address and port in the mobile phone surveillance client.

● Access device via 3G network

Step 1: Set the device network. Please enter Main Menu→Setup→Network tab.

▶ If you use PPPoE to connect device, please enable PPPoE and input username and password received from you ISP in network tab. Then click “Apply”. You can enter Main Menu→Information→Network tab to see the IP address. If you want to utilize dynamic domain name, please apply for a domain name in a DNS server supported by the device.

▶ If you have a static WAN IP address, please enter Main Menu→Setup→Network tab to input your IP address, gateway and port.

▶ If you use LAN IP address, please enter Main Menu→Setup→Network tab to input your IP address, gateway and port and then forward IP address and port number in virtual server setup of the router or virtual server(If you has enabled the UPnP function in both the device and router, you can skip this step). Port forwarding setting may be different in different routers and servers. Please refer to the router’s manual for details. After you forward your LAN IP address and port, please check the WAN IP address in the router or server.

Step 2: Add the WAN IP address or domain name in mobile phone surveillance client.

7.2 By Phones with iPhone OS

- **Install through Iphone.**

Step 1: Open App Store software as shown in the figure on the left.

Step2: Search “Provision Cam” and click “Free” button as shown in the figure on the right.

Step 3: Click “Install App” button as shown in the figure on the left.

Step 4: Input iTunes Store password and then click “OK”. The software will be installed automatically.

- **Install Software through PC**

Step 1: Install iTunes store in PC and then login.

Step 2: Connect iPhone and PC.

Step 3: Search and select “Provision Cam”.

Step 4: Click “Download” button.

Step 5: Input username and password.

Step 6: Synchronously apply "Provision Cam" software to iPhone/iPad.



- "Provision Cam" Instruction

1. Login

Step 1: Choose network type. There are two network connection ways: 3G/3G +WIFI, enhanced video quality. This network supports main stream and sub stream. The real-time image will be displayed by using sub stream.

3G, normal video quality compared to the former network type.

Step 2: Input server, account and password.



Server: WAN IP address (or domain name) plus HTTP port of the device. For example: 210.21.183:89 or 123.dvrdydns.com:89.

Note: The default http port of the device is 80. If modified, use the modified port.

Account and Password: The login account and password of the device. The default account is admin and the default password is 123456.

Step 3: Click **【Login】** button to access the device.

2. Main Interface

There are many buttons in the main interface, such as, screen mode, favorite channel, snap, record, open/close audio, talk, PTZ., etc.

: Image view button. The pictures snapped in the live will be checked by clicking this button.

: Playback button. Click this button to enter into playback interface.

: Settings button. Click this button to set local configuration (Some can also support remote configuration).

: Information button. Click this button to check lots of information including local information, device information, network information, etc.



Chapter 8 IP-Tool



: Server list button. Click this button to add server list.



: Help button. Help you know about the use of this software quickly.



: CMS button. Make you preview the live image of multi-devices.



: Log off button. Click this button to return to the login interface.



: Screen mode button. You can choose 1, 4, 6, 8, 9, 13 or 16 screen display mode.



: Favorite channel display button. If you save your favorite channel in the favorite server list, clicking this button will directly play all favorite channels you have saved.



: Snap button. Choose the channel and click this button to capture the channel image.



: Local record button. Choose the channel and click this button to start recording.



: Open/Close audio. Choose the channel and click this button to open/close the audio of this channel.



: Open/Close talk. Click this button to pop up the servers which support talk function. Select the device to start talking.



: Set video parameter button. Select the channel and click this button to set the video parameters including brightness, hue, saturation and contrast.









: PTZ button. Click this button to pop up PTZ control panel.



: Choose bitrate priority or quality priority according to your network condition.

Channel indicator instruction:

-  : Video loss
-  : Schedule recording
-  : Others
-  : Sensor alarm
-  : Motion alarm
-  : Motion /sensor alarm based recording or manual recording

3. Server list



Click  button to pop up the following picture.

➤ Add device: Click “Add” button in the top right corner to pop up a dialog box as shown in the following left picture. Input the relative information of the device and click “Save” button.

➤ Delete device: Click  button behind the device name to delete this device.

➤ Edit device: Click  button behind the device name to edit the information of this device.

➤ Backup & restore: It is recommended to click “Backup” button to reserve the information of all devices. Then you can click “Restore” button to restore all device information after you re-install the client or delete the device uncarefully.

-  indicates the device has been connected;
-  indicates the device is connecting;
-  indicates the device is not connected.

4. Live Preview

Once you access the device, the system will automatically display the screen mode in accordance with the channel number of the device

Note: The maximum number of channels which can be connected are nine after login.



Chapter 8 IP-Tool

1. Click “Screen mode” button to select channel as shown in Fig 1.
2. When there is video playing in a screen, you can switch the channel by long pressing the screen as shown in Fig 2.
3. When no video is playing in a screen, click this screen to choose channel as shown in Fig 3.
4. When the single channel is playing, you can zoom in/out the image by swiping you finger up and down as shown in Fig 4.
5. When the single channel is playing, the channel can be switched by swiping your finger left or right as shown in Fig 5.
6. When multi channels are playing, drag one channel screen to the other channel screen. This will make these two channels change the position of each other.

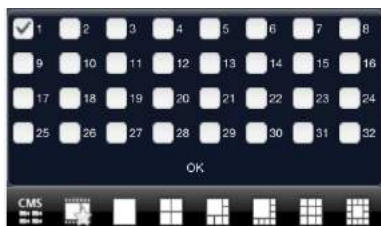

Fig 1

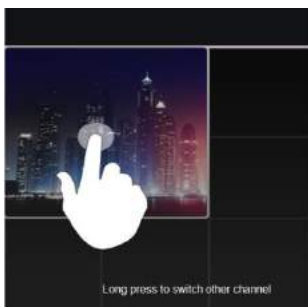

Fig 2

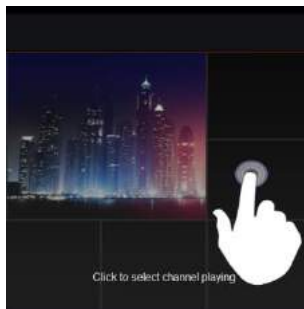

Fig 3

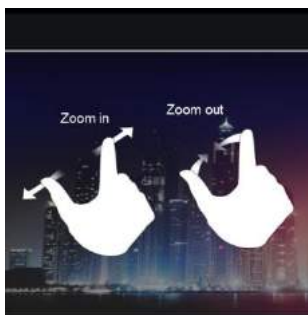

Fig 4

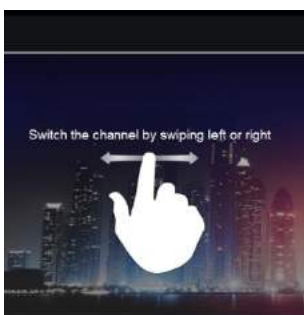





Fig 5

5. CMS Function

This function makes multi-device managements and preview come true.

Step 1: Click  to enable CMS function. When this icon turns green, it means this function is enabled.

Step 2: Click  to choose channel as shown in the right picture. After you choose the channel, click “ok”, the system will display the related image automatically.

- If channels have been added into the group, you can see the images by clicking the group name.
- On viewing the group channel images, click  button and select channels to check other channel images.
- Click “Exit CMS” to exit CMS mode and return to the main interface of the device.

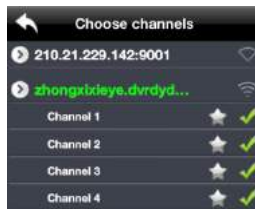

6. Favorite Channel/Group

There are two kinds of favorite channels: favorite channels of the device and favorite group of CMS.

● Favorite channels of the device

Step 1: Click  to enter into device management list. Click the device name to extend channel. Enlighten the channels to save favorite channels as shown in the following picture on the left.

Step 2: Return to the main interface and click  button to play the favorite channels.



● Favorite groups of CMS

Enable CMS function and enlighten the group to save the favorite groups as shown in the following picture on the right.

Then click  button to play. Only one favorite group can be collected.

: Color means the channel or group has been collected. Grey means the channel or group isn't collected.

7. Playback Interface

Click “Playback” button to enter the playback interface. Then click “Search” button to search the file. To play the record by click this file name.

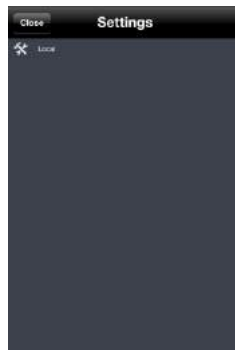

8. Image View

Click  button to view the captured pictures.

9. Settings Interface

In this interface, you can configure the local settings.

10. Information Interface

In this interface, you can view system information.



7.3 By Phones with Android

Software Installation

Step 1: Run “Play Store” (or Google market) program.

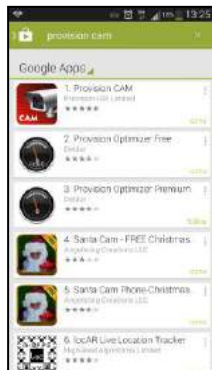

Step 2: Search “Provision Cam”.

Step 3: Press “Install” button.

Step 4: Install the software subject to the notes. Once the downloading is done, the software will install automatically

Login Menu







Step 1: Configure the network of your device and mobile phone.

Step 2: Input the WAN IP address/domain name and port of your device in the sever column. The port should be HTTP port of your device. The default http port of the device is 80. If you have changed your http port, please enter the new port here. For example: 210.21.228.183:89 or 123.dvrtydns.com:89.



Step 3: Input the account and password of your device. The default account name is admin and the default password is 123456.

Step 4: Check “Remember Server” to save the setting. When you login next time, you can click ▼ button to select this server for quick access.

	PTZ
	Snap
	Record
	Talk
	Enable/disable audio
	Hide
	Playing favorite channel

Chapter 8 IP-Tool

Main Menu

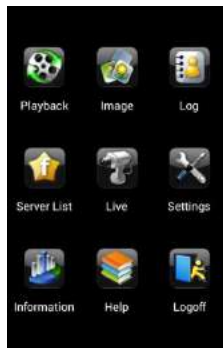

Live View



	The first picture
	The previous picture
	Next picture
	The last picture
	Zoom in
	Zoom out
	Delete

Record Playback:

Click “Playback” in the main menu interface to enter playback interface. Then choose the channel you want to playback. This will take you to see the record file. Click this file to play.



	Pause/Play
	Stop
	Forward
	Backward



Server List:

In the main menu interface, click “Server list” to see the above picture on the left hand.

Add Server: Click button to pop up a window as shown in the above picture on the right hand. Enter the name, server, user and password of the device you want to add. Then

Chapter 8 IP-Tool

click “Save” button to save the server. When you log in next time, you can choose and quickly access this server by clicking the little triangle button in the server column.

Modify Server: Click  button to modify the server information. Delete Server: Click  button to delete the server information.

Settings:

In the main menu interface, click “Settings” to enter the settings interface where you can configure local settings. Click “Local” to enter local settings interface. In this interface, you can set favorite channel and storage.

Favorite Channel:

Check the favorite channels and click “Save” button to save these channels. Then go into live interface and click  button to play these favorite channels.

Storage: Setup the relevant parameters of mobile video.

Information View: view the DVR/NVR basic information as shown in the picture on the right.



8 IP-Tool

Updating through IP-Tool

Chapter 8 IP-Tool

Note: Do not cut off power supply and internet when updating. If the device is unable to start because of the failure of upgrade, it needs to retrofit.



Acquire the IP-Tool from the supplier and then double click the IP-Tool icon to run this software. Then the device can be searched; if the device can't be searched, please check whether the PC and the device connect to the network or not.



Click the device to check its detail information as shown below:



When upgrading the software and kernel, the IP address of PC and device should be at the same network segment. If the network segment is different, user should change the IP address by right clicking the device and then select “network setup”. Modify IP address dialog box will appear as follows:

Chapter 8 IP-Tool

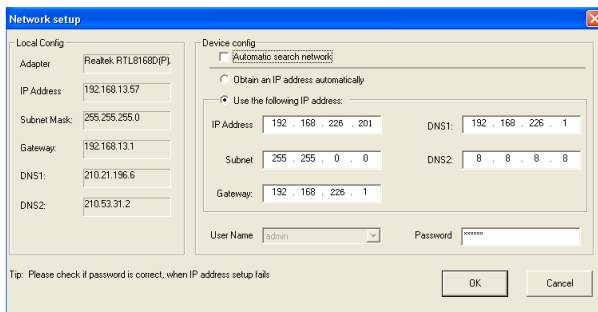

Modify IP address and click OK button to exit the dialog box. After that, IP-Tool will display the new IP address.

● Upgrade Software

Select the device; right click “Update software”. Click “Update” to start upgrading, the progress bar will display as below. When upgrading, please do not disconnect PC and the device and make sure the power is on.

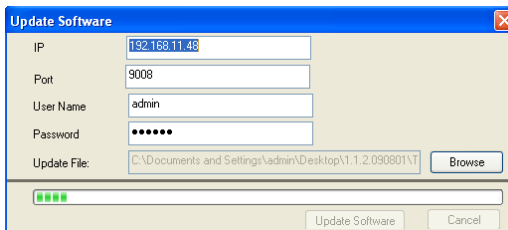

After finishing upgrading, a message box will pop up as below:

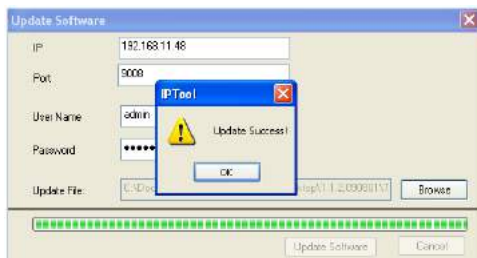

Click OK button to exit the update dialog box, and then the device will restart automatically. Select the device and right click it to select “Update kernel”. This will bring up a dialog box as below:

Chapter 8 IP-Tool

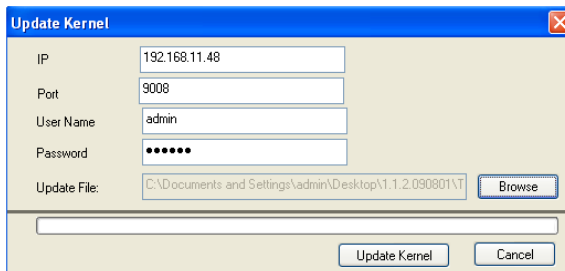

Input the relevant information and click “Browse” button to choose your update file. After that, click “Update Kernel” button to start updating. When upgrading, do not disconnect PC to device and make sure the power is on. The update progress bar will display as below:

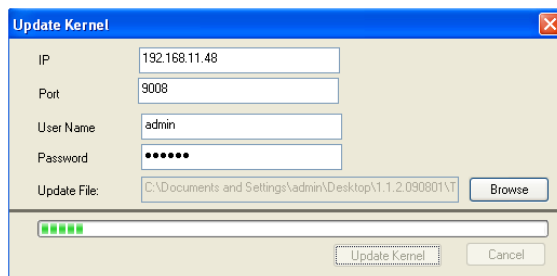

After finishing upgrading, a message box will pop up. After a while, the device will restart automatically.

9 Q & A

1. Q : How to find my password if I forget it?

A: Joint the default line and GND line to reset.

Default IP: 192.168.226.201

User name: admin

Password: 123456

2. Q : Fail to connect devices through IE browser, why?

A: Network doesn't connect well. Please check the connection and make sure it connected well.

B: IP is not available. Reset the valid IP.

C: Web port number has been revised: contact administrator to get the correct port number.

D: Exclude the above reasons. Recover default setting by jointing the default line and GND line.

Note: default IP: 192.168.226.201, mask number: 255.255.255.0

3. Q : IP tool cannot search devices, why?

A: It may be caused by the anti-virus software in your computer. Please exit it and try to search device again.

4. Q : IE cannot download ActiveX control. How can I do?

a. IE browser blocks ActiveX. Please do setup following below.

①Open IE browser. Click Tools-----Internet Options....



②select Security-----Custom Level...Refer to Fig 4-1

③Enable all the sub options under "ActiveX controls and plug-ins". Refer to Fig 4-2

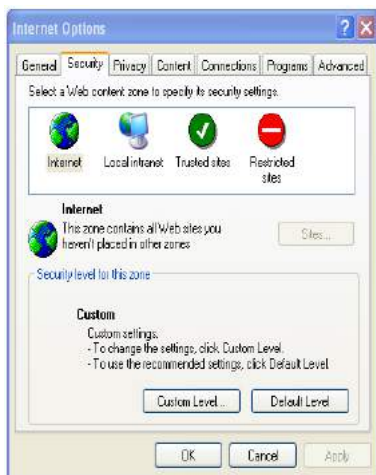

Fig 4-1

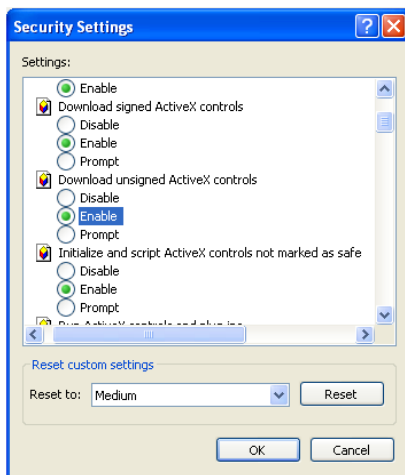

Fig 4-2

④ then click ok to finish setup.

b. Other plug-ins or anti-virus blocks ActiveX. Please uninstall or close them.

5. Q : No sound can be heard, why?

A: Without connect audio input device. Please connect and try again.

B: Without enable audio function at the corresponding channel. Please check AUDIO item to enable this function.

6. Q : Why doesn't the device connect to wireless?

A: Check the statues of wireless router. Please make sure the router is open

B: Check the router and the device port. Please make the router setup is matched with device port.

7. Q: How to do when the device is unable to start normally on upgrading?

If the device is unable to start normally when upgrading, please rename the files suffixed with .tar as updatepack.tar and copy it to the root directory of SD card. Restart the device and then the device will upgrade automatically from the SD card. After finishing upgrading, the user can search the IP address of IP Cam in the IP Tool.

Chapter 10 Specification

10 Specification

Model	I4-390IPVF
Image Sensor	Sony Exmor IMX122 1/3" CMOS
Effective Pixels	1920x1080
Electronic Shutter	1/25s ~ 1/100000s
Day & Night	ICR
Min. Illumination	0lux (IR ON)
Audio compression	G711A
Communication	Two Way Audio
Image Settings	AWB, AES, AGC Adjustable
	Exposure Mode (Auto / Manual)
	BLC, HLC Adjustable
	Sharpness, Saturation, Brightness & Contrast Adjustable
WDR Range	Digital WDR
Noise Reduction	3D-DNR
Image Orientation	Mirror/Flip
Privacy Zone	Yes
Motion Detection	Yes
Video Compression	H.264
Resolution	1080P (1920x1080), 960P (1280x960), 720P (1280x720), VGA (640x480), QVGA (320x240)
Multi-stream	1920x1080 (1~30fps) / 1280x960 (1~30fps) / 1280x720 (1~30fps) / 1280x720 (1~30fps) / 640x480 (1~30fps) / 320x240 (1~30fps)
Bit rate	64Kbps ~ 8Mbps
Encode Mode	VBR/CBR
Image Quality	Five levels under VBR; Free adjustment under CBR
IR Distance	40m
Lens	3.3-12mm
Iris	Fixed Iris
Lens Mount	Φ14 mount
Water-proof	IP66
Bracket	3-Axis
Dimensions	Φ112mm×326mm
Weight(gross)	1115g
Network	RJ45 (+PoE)
Power	DC Socket
Analog Video Output	CVBS (BNCx1)
Mic Connectivity	1Ch Input, 1Ch Output
SD Card	Support TF (64GB Max)
RS485	Yes
Alarm	1Ch Input, 1Ch Output
Remote Monitoring	IE Browsing, CMS 2.0 Control Software, Provision CAM Mobile App for iOS &Android
User Access	Supports simultaneous monitoring for up to 4 users with multi-stream real time transmission
Network Protocol	TCP/IP, UDP, DHCP, NTP, RTSP, PPPoE, DDNS, SMTP, FTP
ONVIF	Yes
Ethernet	100Mbps
PoE	Yes
Power Supply	DC12V/PoE
Work Environment	-10°C-50°C 10%~90% Humidity

Notes:

PROVISION **ISR**

Now you can see!



www.provision-isr.com